

WaterChef®

SMART WATER FILTRATION



INSTALLATION, USE & CARE GUIDE

SHOWER Filtration System

▲ IMPORTANT

Read & Save These Instructions.

This System does not require the services of a plumber.

QUESTIONS?

1.800.879.8909
(int'l +1.775.359.9500)

MON - FRI 8 AM - 5 PM PST

SF-7C

SF-7C-ECO

My System Serial #:

Serial Number is located on back of shower filter housing.

eco/smart

bpa**free**

MADE IN THE
USA
OF FOREIGN & DOMESTIC PARTS



System Certified by IAPMO R&T against NSF/ANSI Standard 177 for the reduction of Free Available Chlorine; NSF/ANSI Standard 372 for Lead-Free Compliance under the US SDWA.



TABLE OF CONTENTS

Introduction	1
Important Use Guidelines	1
Product Specifications	2
System Diagram and Replacement Parts Directory	2
Setup and Installation	3
Replacing the Filter Cartridge	4
Care and Cleaning	5
Troubleshooting	5
Warranty	6

HAVE QUESTIONS OR NEED ASSISTANCE?

WaterChef Customer Care is here to help if you ever have questions or need assistance with your WaterChef Shower Filtration System.

Customer Care Line (U.S. & Canada): 1.800.879.8909 (toll-free)

International Customer Care Line: +1.775.359.9500

Hours of Operation: Mon.-Fri. 8 AM-5 PM PST

Email: customercare@waterchef.com

Website: waterchef.com

Mailing Address: WaterChef Customer Care
3760 Barron Way
Reno, NV 89511

INTRODUCTION

Congratulations on the purchase of your new WaterChef® Premium Shower Filtration System! You have made a wise investment and taken an important step towards substantially reducing your exposure to chlorine and improving water conditions commonly encountered when showering.

Enjoy healthier and smoother skin, softer and more manageable hair, and reduced eye irritation. Additionally, you may notice that you use less soap and conditioner, and if you use hair color products, you may also experience longer-lasting color between treatments.*

WaterChef Premium Shower Filtration Systems are quality crafted from the finest materials and workmanship, and will serve you reliably for years to come when operated and maintained according to the directions contained in this guide.

The most important part of maintaining your System is replacing the Filter Cartridge on a regular interval. Under typical conditions, each Filter Cartridge will provide approximately six months of service.**

**This claim has not been evaluated by IAPMO.*

***Estimated cartridge life is based on two 10 minute showers per day.*

IMPORTANT USE GUIDELINES

1. Read this manual completely before attempting to install or use this product.
2. Replacement Filter Cartridges may be purchased from a WaterChef reseller or online from waterchef.com. To order by phone, contact WaterChef Customer Care at **1.800.879.8909** (int'l +1.775.359.9500).
3. The actual capacity of your Cartridge may vary from the rated capacity. This may be due to the volume of contaminants or sediment present in your water supply.

Replace the Filter Cartridge at the first occurrence of the following:

- Every six months
 - When you notice an odor recurrence
 - When the 10,000 gal. rated capacity of the Filter Cartridge has been reached
4. For this System to continue to perform as tested and represented, be sure to use only genuine, certified WaterChef® RCSF-7 Filter Cartridges.
 5. This System is NOT intended as a drinking water treatment unit. Installation of this product must comply with applicable state and local regulations.
 6. If System malfunctions or becomes damaged, stop use and contact WaterChef.

PRODUCT SPECIFICATIONS

SHOWER FILTRATION SYSTEM (Models: SF-7C, SF-7C-ECO)

Installation	Shower
Rated Capacity (per Cartridge)	10,000 gallons (37,854 L)
Replacement Filter Cartridge	RCSF-7
SF-7C Rated Service Flow @ 80 psi	2.5 gpm (9.5 lpm)
SF-7C-ECO Rated Service Flow @ 80 psi	1.75 gpm (6.6 lpm)
Maximum Working Pressure	100 psig (689.5 kPa)
Minimum Working Pressure.30 psig (206.8 kPa)
Maximum Operating Temperature	140° F (60° C)
Minimum Operating Temperature.34° F (1° C)

Protected under U.S. Patent #: 5,545,314



System Certified by IAPMO R&T against NSF/ANSI Standard 177 for the reduction of Free Available Chlorine; NSF/ANSI Standard 372 for Lead-Free Compliance under the US SDWA.



Refer to Performance Data Sheet for actual contaminant and substance reduction capabilities.

SYSTEM DIAGRAM & REPLACEMENT PARTS DIRECTORY

SHOWER SYSTEM DIAGRAM

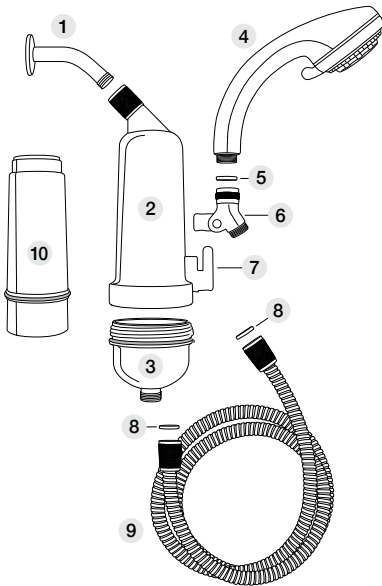

ITEM DESCRIPTION

ITEM	DESCRIPTION
1	Existing Shower Pipe
2	Filter Housing
3	Filter Base*
4	Shower Wand
5	Swivel Gasket
6	Swivel
7	Post
8	Hose Gasket
9	Shower Hose
10	RCSF-7 Filter Cartridge*

*Filter Base and Filter Cartridge include O-ring

SETUP & INSTALLATION

1. Remove existing shower head from shower pipe by turning counterclockwise. *Be sure to also remove any plumber's tape that may be present on the threads.*
2. Thread Housing Collar clockwise onto shower pipe and hand tighten. **(fig. A)**
3. Insert Hose Gaskets into both ends of Hose *(if not already installed)*. **(fig. B)**
4. Thread Hose onto Filter Base and hand tighten. **(fig. C)** *(Note: If your Hose has a hex fitting on one end, it is recommended that the end with the hex fitting be threaded onto the Filter Base.)*
5. Thread opposite end of Hose onto Swivel and hand tighten. **(fig. D)**
6. Thread Swivel onto Shower Wand and then secure Swivel on Filter Housing Post. **(fig. E)**
7. **Prior to using for the first time, direct Shower Wand into the drain and turn water "ON". Allow System to flush for at least 5 minutes or until water runs clear. (fig. F)**
This will remove any fine, black carbon particles left over from the manufacturing process, expel trapped air and condition the Cartridge for normal use. *(This water may be used to water plants.)*

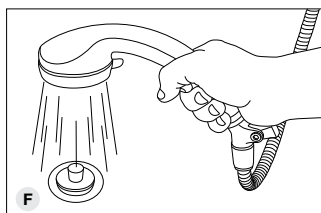
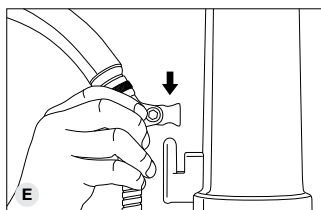
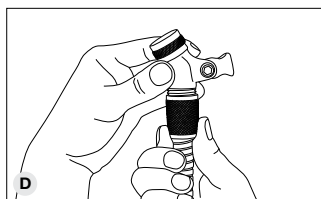
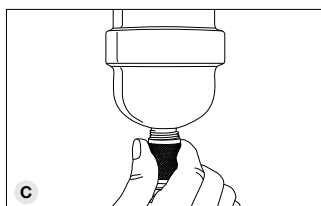
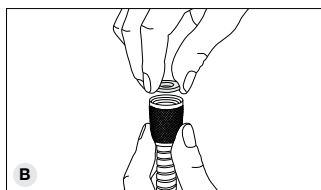
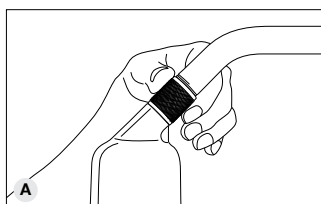

▲ IMPORTANT

Repeat flushing procedure each time a Cartridge is installed.

Congratulations! Your new WaterChef® Shower Filtration System is ready!

NOTE

Plumber's tape is **NOT RECOMMENDED** for installation. The Shower Filter Housing is designed to make a seal at the end of the shower pipe, not on the threads. Using plumber's tape may prevent the shower pipe from fully seating on the Filter Housing Gasket and increase the likelihood of leaks.

Due to continuing product development, actual product appearance may vary from images and illustrations.

REPLACING THE FILTER CARTRIDGE

The most important part of maintaining your WaterChef Shower Filtration System is replacing the Filter Cartridge on a regular service interval. To ensure your System continues to perform as stated in the Performance Data Sheet, the Filter Cartridge should be replaced upon the first occurrence of the following:

- Every six months*
- When you notice an odor recurrence
- When the 10,000 gallon rated capacity of the Filter Cartridge has been reached

1. Towel dry Filter Base and Filter Housing. Hold Filter Housing securely in one hand while turning the Filter Base counter-clockwise with the other. Once loose, pull Filter Base down and away. (fig. G)

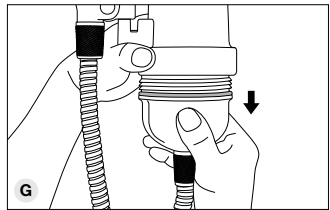

2. Remove spent Filter Cartridge from Filter Base and discard with regular refuse. (fig. H)

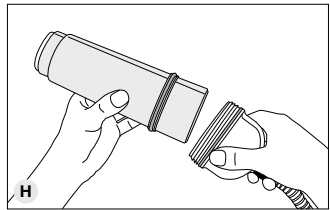

3. Remove protective wrap from new Filter Cartridge and insert into Filter Base. While holding Filter Base securely, insert Cartridge into Filter Housing and thread Filter Base clockwise until tight. **Do NOT over-tighten.** (fig. I)

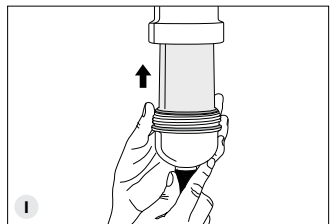

4. **Direct Shower Wand into drain and turn water "ON". Allow System to FLUSH for at least 5 minutes or until water runs clear.** (fig. J) This will remove any fine, black carbon particles left over from the manufacturing process, expel trapped air and condition the Cartridge for normal use. (This water may be used to water plants.)

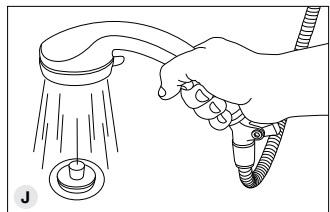

▲ IMPORTANT

Repeat flushing procedure each time a Cartridge is installed.

RECOMMENDATION

For best performance replace Cartridge every six months.*

**Estimated filter cartridge life is based on two 10 minute showers per day and typical water quality conditions. Actual cartridge life may vary.*

CARE AND CLEANING

Cleaning is required when mineral deposits appear on spray nozzles to maintain proper operating conditions. Clean by rubbing hand over nozzles to remove build-up.

Do NOT clean or rinse any part with harsh chemicals, heavy duty cleaners, or abrasives; this may damage the parts or finish and void warranty.

TROUBLESHOOTING

CONDITION

Leaking occurs between existing shower arm and Housing Collar.

REASON

Filter Housing may not be properly attached to shower arm.

SOLUTION

If leak occurs after initial install, remove Filter Housing and confirm that the shower arm threading does not have any plumber's tape or excess mineral buildup. If plumber's tape is present, remove and clean the shower arm with white vinegar to ensure all residue has been removed from the threading. If there is no tape, confirm that any mineral build-up has been removed using either white vinegar or a cleaner designed to remove minerals. Re-attach Filter Housing to ensure that the issue has been resolved.

CONDITION

Shower wand does not stay in position.

REASON

Shower swivel screw has loosened from usage.

SOLUTION

Using a Phillips head screwdriver, tighten the screw on the side of the swivel to desired firmness.

CONDITION

Water is flowing slowly from the Shower Wand.

REASON

Cartridge has become clogged.

SOLUTION

Change your Cartridge. Typically, a decrease in water pressure is due to the Cartridge needing to be changed. A Cartridge typically lasts up to 6 months when used for two 10-min. showers per day. If the system is used more frequently or there are water quality issues, your cartridge may need changed more frequently.

CONDITION

Filter Base is difficult to remove from Filter Housing.

REASON

Excessive water pressure may have caused threads to bind.

SOLUTION

Be certain that your hands, Filter Base and Filter Housing are dry. Grip Filter Base with one hand while securing Filter Housing with the other hand. Unscrew Base to detach.

Pro Tip: *Rubber gloves or a rubber jar opening mat may help if you still experience difficulty. Do NOT use abrasive materials, as this may damage the housing.*



SHOWER FILTRATION SYSTEM

THREE YEAR LIMITED WARRANTY

WaterChef® warrants to the original purchaser that this product will be free from defects in materials and workmanship for a period of three years from the original purchase date.

WaterChef, at its option, will repair or replace this product or any component of the product found to be defective during this warranty period. Replacement will be made with a new or remanufactured product or component. If the product is no longer available, replacement may be made with a similar product of equal or greater value. This is your exclusive warranty.

This warranty is valid for the original retail purchaser from the date of original retail purchase and is not transferable. Keep the original sales receipt. Proof of purchase is required to obtain warranty service. WaterChef dealers do not have the right to alter, modify or change the terms and conditions of this warranty in any way.

This warranty does not cover normal wear of components or damage resulting from any of the following: negligent use or misuse of the product, use contrary to the Installation, Use and Care Guide, disassembly, repair or alteration by anyone other than WaterChef or a WaterChef authorized service center. Further, the warranty does not cover acts of nature, such as fire, flood, tornadoes or hurricanes. This warranty does not cover premature plugging due to excessive sediment or contaminants that may be in your water supply, or damage that results from failure to replace filter cartridges at manufacturer's recommended service intervals.

WaterChef shall not be liable for any incidental or consequential damages caused by the breach of any express or implied warranty. Except to the extent prohibited by applicable law, any implied warranty or merchantability or fitness for a particular purpose is limited in duration to the duration of the above warranty. Some states, provinces or jurisdictions do not allow the exclusion or limitation of the incidental or consequential damages or limitations on how long an implied warranty lasts, so the above limitations or exclusion may not apply to you. This warranty gives you specific legal rights, and you may also have other rights that vary from state to state or province to province.

HOW TO OBTAIN WARRANTY SERVICE

Call 1.800.879.8909 (int'l +1.775.359.9500) or email customercare@waterchef.com. If it is determined that it is necessary to return the product, a Return Authorization Number will be issued. **Products returned without a Return Authorization Number will be refused.** Pack the product in the original carton, or equivalent, using newspaper or other packing materials to protect the product from damage in transit. Before sealing the carton, be sure to include a copy of the original sales receipt along with a note describing the nature of the defect or problem. Be certain to include your return shipping address and Return Authorization Number on the outside of the carton.

Ship the product postage paid to: **WaterChef Customer Care**
3760 Barron Way
Reno, NV 89511

Upon receiving the product, we will repair or replace the product and return it to the return address on the shipping carton, postage pre-paid. *(U.S. customers only)*